

ELECTRIC MODEL AVAILABLE
Please see page 192

DESIGN
RADIATORS



DÉCOR H11

DÉCOR TS4



DÉCOR KH11

DÉCOR

The MYSON DÉCOR range has played a leading role in the world of interior design over the past decade. It treats radiators as decorative items as well as heating devices. With a range of sizes and tube designs available the MYSON DÉCOR range offers a stunning alternative to mainstream radiators.

- Comes in horizontal, vertical and plinth models, in a range of heights from 155mm to 2000mm and lengths from 308mm to 2200mm
- Available in special made to order sizes and selected colours to suit all spaces and tastes
- Electric model also available, please see page 192

DÉCOR

GENERAL SPECIFICATION & TECHNICAL INFORMATION

**CERTIFICATION**

Manufactured and tested to BS EN 442. Carries the BS Kitemark. Produced under a quality management system - ISO 9001:2008 and environmental management system - ISO 14001:2004.

**GUARANTEE**

10 year guarantee from date of purchase against manufacturing defects.

**COLOUR**

Standard stocked finish is white (RAL 9016). For other special colour options please see page 252.

**MATERIAL**

Header tubes: Manufactured from 1.5mm steel.
Heating tubes: Manufactured from 1.25mm steel.
KH models: Manufactured from 1.5mm steel.

**ACCESSORIES**

Touch up paint available on request.

**SYSTEM**

2 pipe pumped indirect domestic and commercial heating applications.

**CONNECTIONS**

2 & 4 x 1/2" BSP as standard.

**AIR VENTS**

Air vent and plug packs are included in the packaging.

**OPERATING PRESSURES**

All models (excl. KH models): Tested to a pressure of 5.2 bar. Working pressure of up to 4 bar.

KH models: Tested to a pressure of 8 bar. Working pressure of up to 5 bar.

**OPERATING TEMPERATURE**

Maximum 100°C.

**DELIVERY**

Stocked items (white): 2 - 5 working days.
Non-stocked items and colour: 6 - 8 weeks.

**VALVES**

Please see page 205.

**BIM**

Visit our website to download the BIM components
www.myson.co.uk/bim

**SPECIALS**

Please refer to the full DÉCOR technical guide for special sizes and colour options.

For more general information, please see page 250.

CONNECTION OPTIONS

2 & 4 x 1/2" BSP

IMPORTANT: MYSON DÉCOR radiators are high performance, universal radiators that come with a choice of connection options.

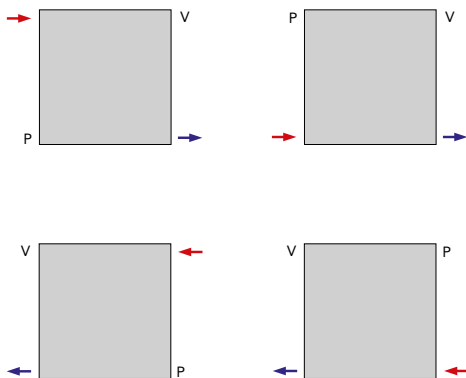
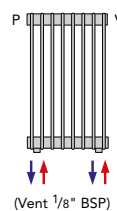
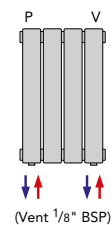
H11, H21, H22, H28, KH11 & KH22**TS4****V10 & V20**

NB: FOR KH11 & KH22 ONLY: Flow separation screws are supplied with each radiator and each screw must be fastened and tightened. Failure to correctly fasten the screws will result in the product not functioning correctly and may cause the product to leak. Please refer to the installation instructions on our website for more information.
TBSE (Top Bottom Same End) only available for KH models.



WEIGHTS & WATER CONTENTS PER METRE LENGTH											WEIGHTS & WATER CONTENTS PER TUBE					
Type	Nominal Height (mm)										Nominal Height (mm)					
	155		305		430 - 455		574 - 605		755		1600		1800		2000	
	Weight (kg)	Water Content (l)	Weight (kg)	Water Content (l)	Weight (kg)	Water Content (l)	Weight (kg)	Water Content (l)	Weight (kg)	Water Content (l)	Weight (kg)	Water Content (l)	Weight (kg)	Water Content (l)	Weight (kg)	Water Content (l)
KH11	-	-	-	-	19.85	3.33	26.15	4.44	-	-	-	-	-	-	-	-
KH22	-	-	-	-	36.93	6.66	49.01	8.88	-	-	-	-	-	-	-	-
V10	-	-	-	-	-	-	-	-	-	-	2.63	1.08	2.93	1.19	3.23	1.30
V20	-	-	-	-	-	-	-	-	-	-	5.03	1.97	5.63	2.20	6.23	2.42
H28	10.52	2.96	21.04	5.92	-	-	-	-	-	-	-	-	-	-	-	-
H11	-	-	-	-	15.78	4.44	21.04	5.92	26.30	7.40	-	-	-	-	-	-
H21	-	-	-	-	24.78	7.80	33.04	10.40	41.30	13.00	-	-	-	-	-	-
H22	-	-	-	-	30.18	7.80	40.24	10.40	50.30	13.00	-	-	-	-	-	-
TS4	-	-	-	-	-	-	-	-	-	-	-	-	2.75	1.10	3.05	1.22

n-COEFFICIENTS								
Type	Nominal Height (mm)							
	155	305	430 - 455	574 - 605	755	1600	1800	2000
KH11	-	-	1.300	1.320	-	-	-	-
KH22	-	-	1.350	1.370	-	-	-	-
V10	-	-	-	-	-	1.317	1.323	1.320
V20	-	-	-	-	-	1.318	1.320	1.321
H28	1.210	1.245	-	-	-	-	-	-
H11	-	-	1.262	1.266	1.269	-	-	-
H21	-	-	1.288	1.289	1.289	-	-	-
H22	-	-	1.300	1.299	1.298	-	-	-
TS4	-	-	-	-	-	-	1.303	1.317

MOUNTING POSITIONS, DIMENSIONS & WALL BRACKETS - DÉCOR KH MODELS

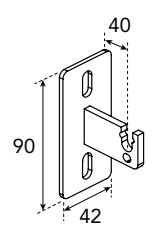
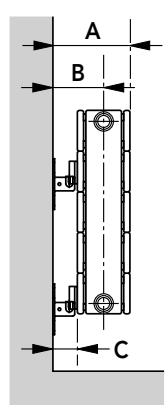

WA11 Wall Bracket

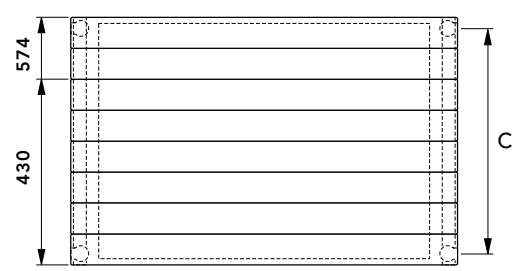
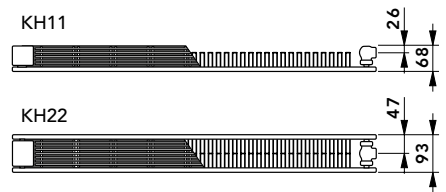

Radiator Models	Overall Height (mm)	A (mm)	B (mm)	C (mm)
KH11	430 - 574	87	45	19
KH22	430 - 574	135	89	42

Overall Height (mm)	430	574
Connection Spacing C (mm)	390	534

*Lengths 600 to 1600mm = 4 brackets. Lengths 1800 to 2000mm = 6 brackets.

NB: All measurements are nominal.

DÉCOR

TECHNICAL INFORMATION (cont...)

MOUNTING POSITIONS, DIMENSIONS & WALL BRACKETS - DÉCOR V10 & V20 MODELS

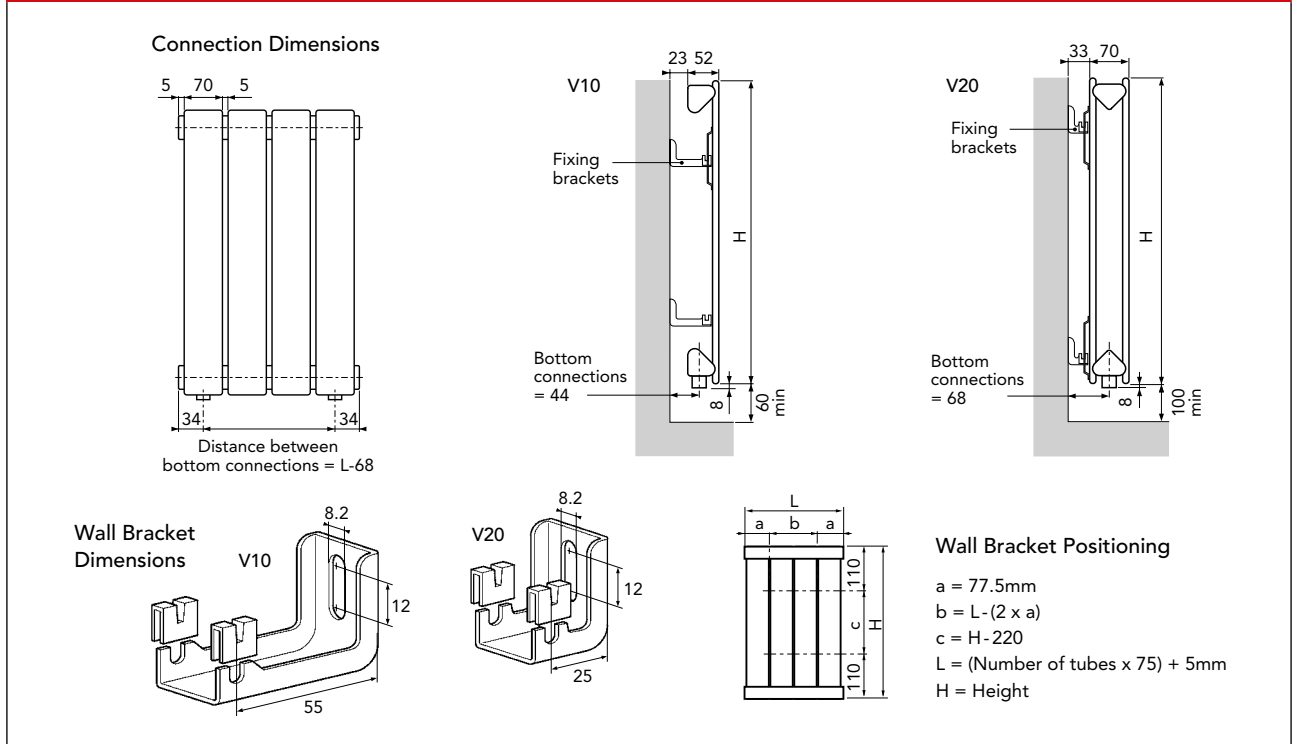

MOUNTING POSITIONS, DIMENSIONS & WALL BRACKETS - DÉCOR H28 FLOOR MODEL

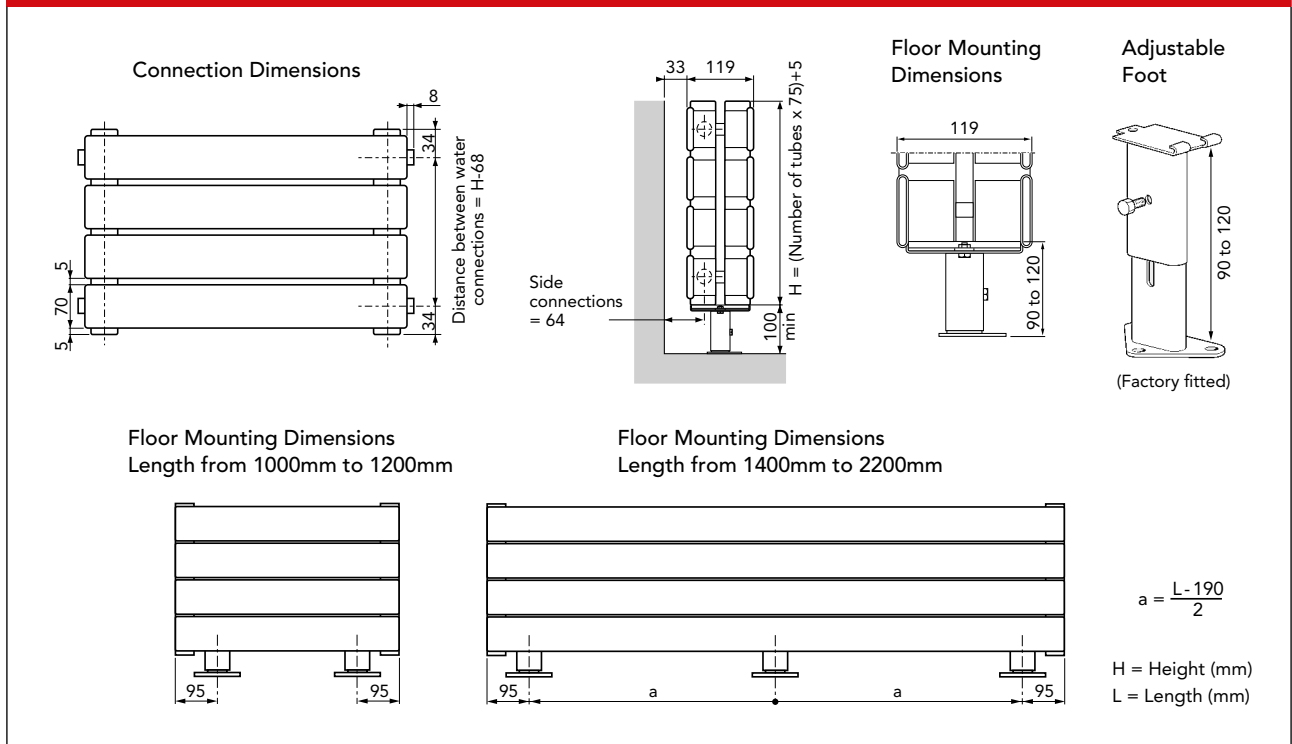



MOUNTING POSITIONS, DIMENSIONS & WALL BRACKETS - DÉCOR H11, H21, H22 & H28 WALL MODELS

Connection Dimensions

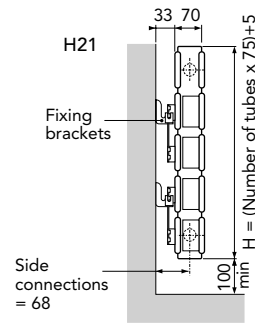
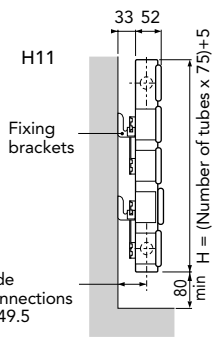
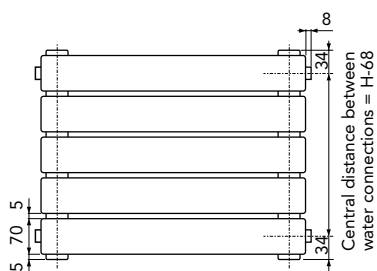

H = Height (mm)
L = Length (mm)

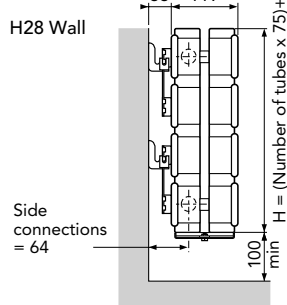
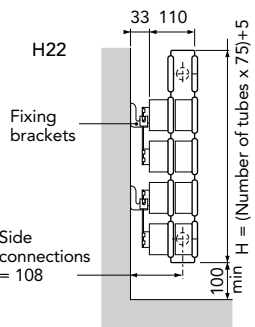

Wall Bracket Dimensions

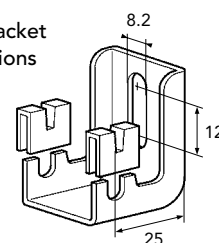

**Wall Bracket Positioning
Length from 600mm to 1200mm**

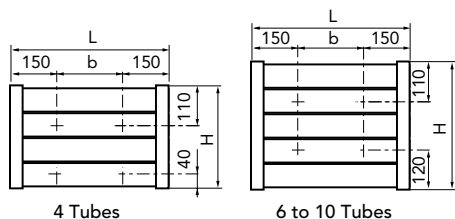

$b = L - 300$

$H = (\text{Number of tubes} \times 75) + 5\text{mm}$

**Wall Bracket Positioning
Length from 1400mm to 2200mm**

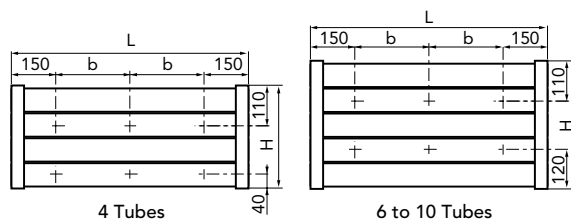

$b = \frac{L - 300}{2}$

$H = (\text{Number of tubes} \times 75) + 5\text{mm}$

L = Length

MOUNTING POSITIONS, DIMENSIONS & WALL BRACKETS - DÉCOR TS4 MODEL

Connection Dimensions

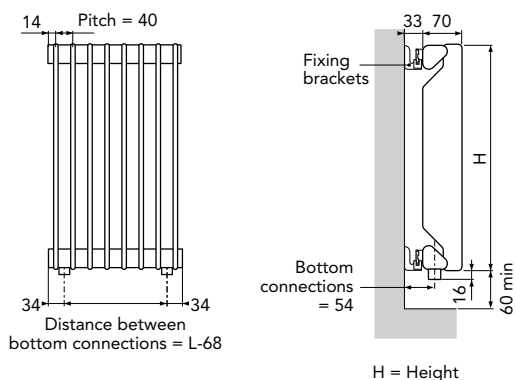

Wall Bracket Positioning

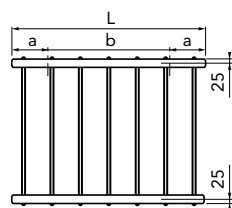

$a = 74\text{mm}$

$b = L - (2 \times a)$

L = Length

Wall Bracket Dimensions

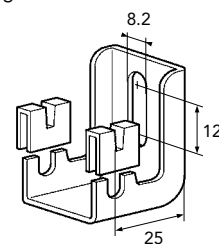

NB: All measurements are nominal.



DÉCOR HEAT OUTPUTS

DÉCOR KH11 HORIZONTAL



Nominal Height	Nominal Length (mm)	No. of Tubes
430mm	600	6
	800	6
	1000	6
	1200	6
	1400	6
	1800	6

Heat Outputs @ ΔT 50°C		Heat Outputs @ ΔT 30°C		Order Code
Watts	Btu/h	Watts	Btu/h	
456	1556	235	802	KH11 0430 0600
608	2074	313	1068	KH11 0430 0800
760	2593	391	1334	KH11 0430 1000
912	3112	469	1600	KH11 0430 1200
1064	3630	547	1866	KH11 0430 1400
1368	4668	704	2402	KH11 0430 1800

574mm	600	8
	800	8
	1000	8
	1200	8
	1400	8
	1800	8
	2000	8

553	1887	282	962	KH11 0574 0600
737	2515	376	1283	KH11 0574 0800
921	3142	470	1604	KH11 0574 1000
1105	3770	564	1924	KH11 0574 1200
1289	4398	658	2245	KH11 0574 1400
1658	5657	846	2887	KH11 0574 1800
1842	6285	940	3207	KH11 0574 2000

DÉCOR KH22 HORIZONTAL



430mm	600	6
	800	6
	1000	6
	1200	6
	1400	6
	1800	6

806	2750	405	1382	KH22 0430 0600
1074	3664	540	1842	KH22 0430 0800
1343	4582	675	2303	KH22 0430 1000
1612	5500	810	2764	KH22 0430 1200
1880	6415	945	3224	KH22 0430 1400
2417	8247	1215	4146	KH22 0430 1800

574mm	600	8
	800	8
	1000	8
	1200	8
	1400	8
	1800	8
	2000	8

955	3258	474	1617	KH22 0574 0600
1274	4347	632	2156	KH22 0574 0800
1592	5432	790	2695	KH22 0574 1000
1910	6517	948	3235	KH22 0574 1200
2229	7605	1106	3774	KH22 0574 1400
2866	9779	1422	4852	KH22 0574 1800
3184	10864	1580	5391	KH22 0574 2000

DÉCOR V10 VERTICAL

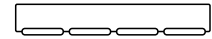

Nominal Height	Nominal Length (mm)	No. of Tubes
1600mm	605	8
1800mm	455	6
	605	8
	755	10
2000mm	455	6
	605	8
	755	10

Heat Outputs @ ΔT 50°C		Heat Outputs @ ΔT 30°C		Order Code
Watts	Btu/h	Watts	Btu/h	
1056	3603	534	1822	8V10160
892	3044	451	1539	6V10180
1190	4060	602	2054	8V10180
1487	5074	752	2566	10V10180
991	3381	504	1720	6V10200
1322	4511	672	2293	8V10200
1652	5637	840	2866	10V10200

DÉCOR V20 VERTICAL

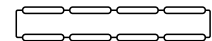

1600mm	605	8
1800mm	455	6
	605	8
	755	10
2000mm	455	6
	605	8
	755	10

1606	5480	817	2788	8V20160
1339	4569	682	2327	6V20180
1786	6094	909	3102	8V20180
2232	7616	1136	3876	10V20180
1474	5029	750	2559	6V20200
1965	6705	1000	3412	8V20200
2456	8380	1250	4265	10V20200

DÉCOR H28 FLOOR

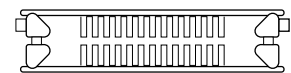

155mm	1000	2
	1400	2
	1800	2
	2200	2
305mm	1000	4
	1400	4
	1800	4
	2200	4

682	2327	366	1249	2H28100
955	3258	512	1747	2H28140
1228	4190	659	2249	2H28180
1500	5118	805	2747	2H28220
1195	4077	641	2187	4H28100
1673	5708	897	3061	4H28140
2151	7339	1154	3937	4H28180
2629	8970	1410	4811	4H28220

DÉCOR H28 WALL

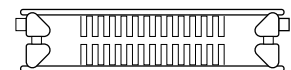

305mm	1000	4
	1400	4
	1800	4
	2200	4

1195	4077	641	2187	4H28100W
1673	5708	897	3061	4H28140W
2151	7339	1154	3937	4H28180W
2629	8970	1410	4811	4H28220W



DÉCOR

HEAT OUTPUTS (cont...)

DÉCOR H11 HORIZONTAL



Nominal Height	Nominal Length (mm)	No. of Tubes
455mm	600	6
	700	6
	800	6
	900	6
	1000	6
	1200	6
	1400	6
	1600	6
	1800	6
2000	6	

605mm	600	8
	700	8
	800	8
	900	8
	1000	8
	1200	8
	1400	8
	1600	8
	1800	8
2000	8	

755mm	600	10
	700	10
	800	10
	900	10
	1000	10
	1200	10
	1400	10
	1600	10
	1800	10
2000	10	

Heat Outputs @ ΔT 50°C		Heat Outputs @ ΔT 30°C		Order Code
Watts	Btu/h	Watts	Btu/h	
478	1631	251	856	6H11060
558	1904	293	1000	6H11070
638	2177	335	1143	6H11080
717	2446	376	1283	6H11090
797	2719	419	1430	6H11100
956	3262	503	1716	6H11120
1116	3808	587	2003	6H11140
1275	4350	670	2286	6H11160
1435	4896	754	2573	6H11180
1594	5439	838	2859	6H11200

602	2054	317	1082	8H11060
702	2395	370	1262	8H11070
802	2736	422	1440	8H11080
903	3081	475	1621	8H11090
1003	3422	528	1802	8H11100
1204	4108	634	2163	8H11120
1404	4790	739	2521	8H11140
1605	5476	845	2883	8H11160
1805	6159	950	3241	8H11180
2006	6844	1056	3603	8H11200

721	2460	379	1293	10H11060
841	2869	442	1508	10H11070
962	3282	506	1726	10H11080
1082	3692	569	1941	10H11090
1202	4101	632	2156	10H11100
1442	4920	758	2586	10H11120
1683	5742	885	3020	10H11140
1923	6561	1011	3450	10H11160
2164	7384	1138	3883	10H11180
2404	8202	1264	4313	10H11200

DÉCOR H21 HORIZONTAL



455mm	600	6
	700	6
	800	6
	900	6
	1000	6
	1200	6
	1400	6
	1600	6
	1800	6
2000	6	

605mm	600	8
	700	8
	800	8
	900	8
	1000	8
	1200	8
	1400	8
	1600	8
	1800	8
2000	8	

678	2313	355	1211	6H21060*
791	2699	414	1413	6H21070*
904	3084	473	1614	6H21080*
1017	3470	532	1815	6H21090*
1130	3856	591	2016	6H21100*
1356	4627	709	2419	6H21120*
1582	5398	827	2822	6H21140*
1808	6169	946	3228	6H21160*
2034	6940	1064	3630	6H21180*
2260	7711	1182	4033	6H21200*

833	2842	435	1484	8H21060*
972	3316	508	1733	8H21070*
1110	3787	580	1979	8H21080*
1249	4262	653	2228	8H21090*
1388	4736	725	2474	8H21100*
1666	5684	870	2968	8H21120*
1943	6630	1015	3463	8H21140*
2221	7578	1160	3958	8H21160*
2498	8523	1305	4453	8H21180*
2776	9472	1450	4947	8H21200*

*Non-stock - made to order only.

DÉCOR H21 HORIZONTAL (cont...)

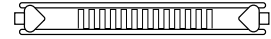

Nominal Height	Nominal Length (mm)	No. of Tubes
755mm	600	10
	700	10
	800	10
	900	10
	1000	10
	1200	10
	1400	10
	1600	10
	1800	10
	2000	10

Heat Outputs @ ΔT 50°C		Heat Outputs @ ΔT 30°C		Order Code
Watts	Btu/h	Watts	Btu/h	
978	3337	511	1744	10H21060*
1141	3893	596	2034	10H21070*
1304	4449	682	2327	10H21080*
1467	5005	767	2617	10H21090*
1630	5562	852	2907	10H21100*
1956	6674	1022	3487	10H21120*
2282	7786	1193	4071	10H21140*
2608	8898	1363	4651	10H21160*
2934	10011	1534	5234	10H21180*
3260	11123	1704	5814	10H21200*

*Non-stock - made to order only.

DÉCOR H22 HORIZONTAL

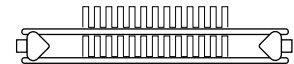

455mm	600	6
	700	6
	800	6
	900	6
	1000	6
	1200	6
	1400	6
	1600	6
	1800	6
	2000	6

833	2842	433	1477	6H22060
972	3316	505	1723	6H22070
1110	3787	578	1972	6H22080
1249	4262	650	2218	6H22090
1388	4736	722	2463	6H22100
1666	5684	866	2955	6H22120
1943	6630	1011	3450	6H22140
2221	7578	1155	3941	6H22160
2498	8523	1300	4436	6H22180
2776	9472	1444	4927	6H22200

605mm	600	8
	700	8
	800	8
	900	8
	1000	8
	1200	8
	1400	8
	1600	8
	1800	8
	2000	8

1027	3504	534	1822	8H22060
1198	4088	623	2126	8H22070
1369	4671	712	2429	8H22080
1540	5254	801	2733	8H22090
1711	5838	890	3037	8H22100
2053	7005	1068	3644	8H22120
2395	8172	1246	4251	8H22140
2738	9342	1424	4859	8H22160
3080	10509	1602	5466	8H22180
3422	11676	1780	6073	8H22200

755mm	600	10
	700	10
	800	10
	900	10
	1000	10
	1200	10
	1400	10
	1600	10
	1800	10
	2000	10

1206	4115	628	2143	10H22060
1407	4801	732	2498	10H22070
1608	5486	837	2856	10H22080
1809	6172	941	3211	10H22090
2010	6858	1046	3569	10H22100
2412	8230	1255	4282	10H22120
2814	9601	1464	4995	10H22140
3216	10973	1674	5712	10H22160
3618	12345	1883	6425	10H22180
4020	13716	2092	7138	10H22200

DÉCOR TS4

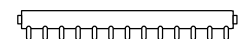

1800mm	308	8
	428	11
	508	13
	628	16

832	2839	423	1443	8TS4180
1144	3903	581	1982	11TS4180
1352	4613	687	2344	13TS4180
1664	5678	845	2883	16TS4180

2000mm	308	8
	428	11
	508	13
	628	16

936	3194	480	1638	8TS4200
1287	4391	660	2252	11TS4200
1521	5190	780	2661	13TS4200
1872	6387	960	3276	16TS4200