



DEE

DEE is a high quality, floor standing combination radiator that will add a classic, vintage feel to your bathroom. With a beautiful COLUMN radiator nestled inbetween a traditional elegant chrome frame, this radiator offers you the best of both worlds.



DIMENSIONS

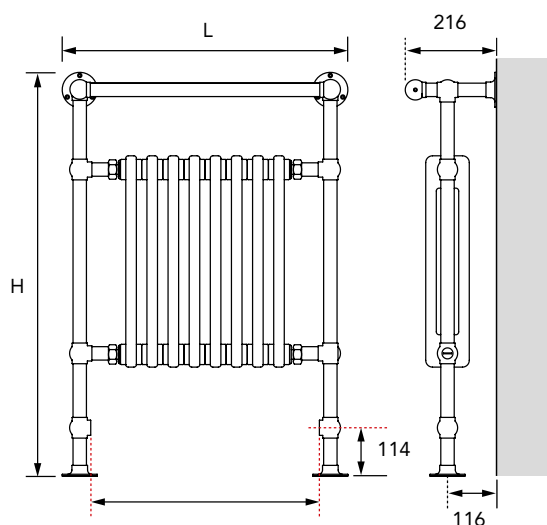

VR1/4 = 341
VR1 = 541
VR2 = 641
VR3 = 741













WEIGHTS & n-COEFFICIENTS

Model	Weight (kg)	n-Coefficient
VR1/4	15.60	1.224
VR1	21.30	1.224
VR2	24.40	1.224
VR3	27.00	1.224

DUAL FUEL HEATER KITS

Model	Dual Fuel Order Code
VR1/4	PTC300
VR1	PTC400
VR2/VR3	PTC500

GENERAL SPECIFICATION

- 
CERTIFICATION
 Manufactured and tested to BS EN 442. Carries the BS Kitemark. Produced under an environmental management system - ISO 14001:2004.
- 
GUARANTEE
 10 year guarantee from date of purchase against manufacturing defects.
- 
COLOUR
 Frame finished in chrome. Radiator in white (RAL 9016).
- 
MATERIAL
 Frame manufactured from brass. Radiator manufactured from steel.
- 
ACCESSORIES
 Please see page 124.
- 
SYSTEM
 2 pipe pumped indirect domestic and commercial heating applications.
- 
CONNECTIONS
 2 x 1/2" BSP as standard.
- 
AIR VENTS
 Integrated.
- 
OPERATING PRESSURES
 Tested to a pressure of 9.6 bar. Working pressure of up to 7.4 bar.
- 
DUAL FUEL
 PTC dual fuel heater kit options available. Please see table above or page 124.
- 
APM® TECHNOLOGY
 PTC heater kit comes with APM® technology. Please see page 251.
- 
DELIVERY
 2 - 5 working days.
- 
VALVES
 Please see page 124.

For more general information, please see page 250.

Order Code	Nominal Height (H) (mm)	Nominal Length (L) (mm)	Heat Outputs @ ΔT 50°C		Heat Outputs @ ΔT 30°C		Dual Fuel Rating (Watts)
			Watts	Btu/h	Watts	Btu/h	
VR1/4	955	476	423	1443	226	771	300
VR1	955	676	602	2054	322	1099	400
VR2	955	776	692	2361	370	1262	500
VR3	955	876	783	2672	419	1430	500