

















INN is a simple but stylish floor standing design that will enhance any bathroom. It has a classic, minimalistic look that is also very practical, making it an ideal choice for creating an understated, traditional feel. It is manufactured from quality brass with a highly polished chrome finish.

GENERAL SPECIFICATION

-  **CERTIFICATION**
Manufactured and tested to BS EN 442. Carries the BS Kitemark. Produced under an environmental management system - ISO 14001:2004.
-  **GUARANTEE**
10 year guarantee from date of purchase against manufacturing defects.
-  **COLOUR**
Finished in chrome.
-  **MATERIAL**
Manufactured from brass.
-  **ACCESSORIES**
Please see page 124.
-  **SYSTEM (INDIRECT)**
2 pipe pumped indirect domestic and commercial heating applications.
-  **SYSTEM (DIRECT)**
Suitable for direct systems. Please refer to page 251 for information on dezincification.

-  **CONNECTIONS**
2 x 1/2" BSP as standard.
-  **AIR VENTS**
Integrated.
-  **OPERATING PRESSURES**
Tested to a pressure of 6.9 bar. Working pressure of up to 5.3 bar.
-  **DUAL FUEL**
PTC100 dual fuel heater kit available. Please see page 124.
-  **APM® TECHNOLOGY**
PTC heater kit comes with APM® technology. Please see page 251.
-  **DELIVERY**
2 - 5 working days.
-  **VALVES**
Please see page 124.

For more general information, please see page 250.

DIMENSIONS

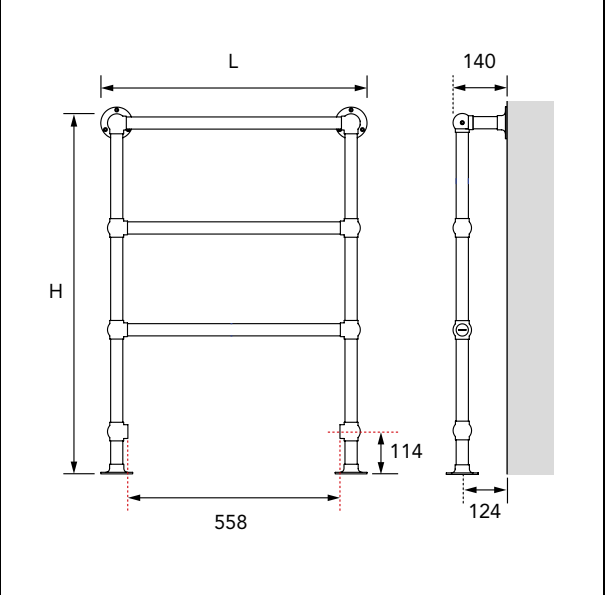

WEIGHT

Model	Weight (kg)
B24/1	8.50

Order Code	Nominal Height (H) (mm)	Nominal Length (L) (mm)	Heat Outputs @ ΔT 50°C		Heat Outputs @ ΔT 30°C		Dual Fuel Rating
			Watts	Btu/h	Watts	Btu/h	
B24/1	955	693	146*	498*	79*	269*	100

*Outputs NPD, see page 251.