









MERSEY

MERSEY is an extremely functional radiator. It combines all the advantages of a PREMIER HE radiator and towel warmer for a truly practical design. It is manufactured from high quality brass with an attractive polished chrome plated finish. MERSEY is ideal for use not just in bathrooms but also kitchens, cloakrooms and other small areas.



GENERAL SPECIFICATION

- 
CERTIFICATION
 Manufactured and tested to BS EN 442. Carries the BS Kitemark. Produced under an environmental management system - ISO 14001:2004.
- 
SYSTEM
 2 pipe pumped indirect domestic and commercial heating applications.
- 
CONNECTIONS
 2 x 1/2" BSP as standard.
- 
AIR VENTS
 Integrated.
- 
OPERATING PRESSURES
 Tested to a pressure of 6.9 bar. Working pressure of up to 5.3 bar.
- 
DELIVERY
 2 - 5 working days.
- 
VALVES
 Please see page 118.
- 
GUARANTEE
 10 year guarantee from date of purchase against manufacturing defects.
- 
COLOUR
 Frame finished in chrome. Radiator in white (RAL 9016).
- 
MATERIAL
 Frame manufactured from brass. Radiator manufactured from steel.

For more general information, please see page 242.

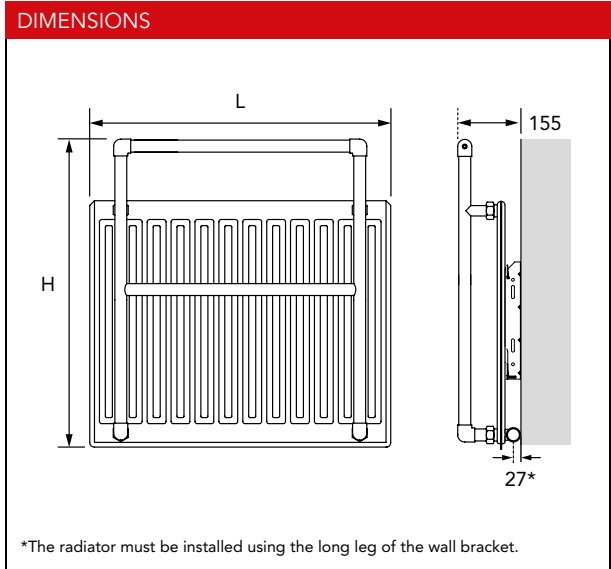

WEIGHTS

Model	Weight (kg)
MTR2	11.10
MTR4	15.10

Order Code	Nominal Height (H) (mm)	Nominal Length (L) (mm)	Heat Outputs @ ΔT 50°C		Heat Outputs @ ΔT 30°C	
			Watts	Btu/h	Watts	Btu/h
MTR2	655	640	385*	1314*	208*	709*
MTR4	809	745	564*	1924*	295*	1007*

*Outputs NPD, see page 243.