

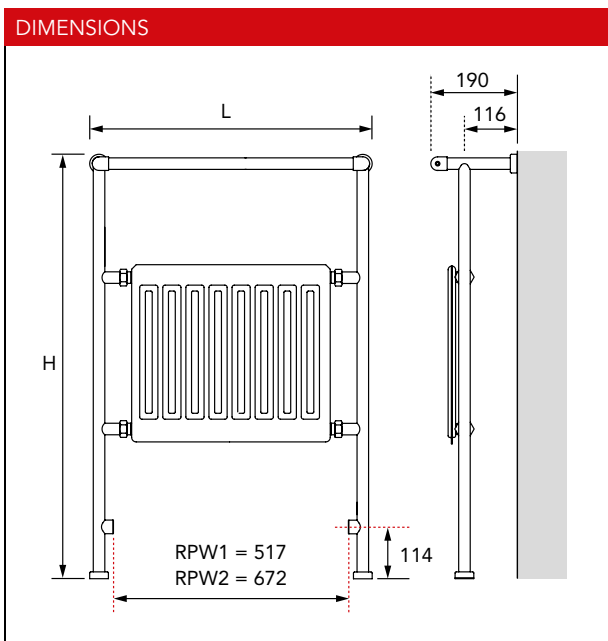

# OUSE

OUSE is a highly practical combination radiator. At its centre is a PREMIER HE radiator that produces high heat outputs. This is surrounded by a functional round tube frame that is manufactured from high quality brass and has an attractive polished chrome plated finish.



**WEIGHTS & n-COEFFICIENTS**

Model	Weight (kg)	n-Coefficient
RPW1	10.90	1.212
RPW2	12.40	1.212

## GENERAL SPECIFICATION

- CERTIFICATION**  
Manufactured and tested to BS EN 442. Carries the BS Kitemark. Produced under an environmental management system - ISO 14001:2004.
- SYSTEM**  
2 pipe pumped indirect domestic and commercial heating applications.
- CONNECTIONS**  
2 x 1/2" BSP as standard.
- AIR VENTS**  
Integrated.
- OPERATING PRESSURES**  
Tested to a pressure of 6.9 bar. Working pressure of up to 5.3 bar.
- DELIVERY**  
2 - 5 working days.
- VALVES**  
Please see page 118.
- 10 GUARANTEE**  
10 year guarantee from date of purchase against manufacturing defects.
- COLOUR**  
Frame finished in chrome. Radiator in white (RAL 9016).
- MATERIAL**  
Frame manufactured from brass. Radiator manufactured from steel.
- A ACCESSORIES**  
Please see page 118.

For more general information, please see page 242.

Order Code	Nominal Height (H) (mm)	Nominal Length (L) (mm)	Heat Outputs @ ΔT 50°C		Heat Outputs @ ΔT 30°C	
			Watts	Btu/h	Watts	Btu/h
RPW1	934	622	290	989	156	532
RPW2	934	777	359	1225	193	659