



PLAN COMPACT PLUS

PLAN COMPACT PLUS



## PLAN COMPACT & PLAN COMPACT PLUS













PLAN COMPACT

Brand new to the MYSON range, the sleek flat front panel design of the PLAN COMPACT offers a contemporary alternative to the traditional panel radiator. Whilst maintaining all of the benefits of the PLAN COMPACT, the PLAN COMPACT PLUS model takes this modern styling one step further with a decorative, rather than flat, front panel. Both models feature side panels and a top grille to achieve a radiator with a minimalist feel that combines good looks with leading performance.

- Available in 4 heights and 12 lengths, ranging from 400mm to 3000mm, the PLAN COMPACT comes in over 120 stocked sizes, while the PLUS model is offered in 78 stocked sizes
- Both models feature Type 11, Type 21 and Type 22 profiles, with the PLAN COMPACT additionally available as a Type 33 profile

## PLAN COMPACT & PLAN COMPACT PLUS

### GENERAL SPECIFICATION & TECHNICAL INFORMATION

- 
**CERTIFICATION**  
 Manufactured and tested to BS EN 442. Carries the BS Kitemark. Produced under a quality management system - ISO 9001:2008 and environmental management system - ISO 14001:2004.
- 
**GUARANTEE**  
 10 year guarantee from date of purchase against manufacturing defects.
- 
**COLOUR**  
 All radiators are de-greased, phosphated and primer coated. An epoxy polyester finishing coat in white (RAL 9016) is applied to all front and rear surfaces.
- 
**ACCESSORIES**  
 Touch up paint available on request.
- 
**SYSTEM**  
 2 pipe pumped indirect domestic and commercial heating applications.
- 
**CONNECTIONS**  
 4 x 1/2" BSP. Please see below.
- 
**AIR VENTS**  
 Air vent and plug packs are included in the packaging.
- 
**OPERATING PRESSURES**  
 Tested to a pressure of 13 bar. Working pressure of up to 10 bar.
- 
**OPERATING TEMPERATURE**  
 Maximum 100°C.
- 
**DELIVERY**  
 2 - 5 working days.
- 
**VALVES**  
 Please see page 197.
- 
**BIM**  
 Visit our website to download the BIM components [www.myson.co.uk/bim](http://www.myson.co.uk/bim)

For more general information, please see page 242.

WEIGHTS & WATER CONTENTS PER METRE LENGTH								
Type	Nominal Height (mm)							
	300		400		500		600	
	Weight (kg)	Water Content (l)	Weight (kg)	Water Content (l)	Weight (kg)	Water Content (l)	Weight (kg)	Water Content (l)
11	11.70	1.50	16.10	2.20	20.50	2.90	24.80	3.40
21	-	-	-	-	23.70*	5.20*	33.70	6.10
22	19.10	3.20	25.10	4.20	31.50	5.20	38.00	6.10
33*	26.90	5.10	36.70	6.30	42.20	7.50	56.40	8.80

\*PLAN COMPACT only.

n-COEFFICIENTS				
Type	Nominal Height (mm)			
	300	400	500	600
11	1.2820	1.2824	1.2827	1.2831
21	-	-	1.2907*	1.2967
22	1.3000	1.3098	1.3197	1.3295
33*	1.3159	1.3245	1.3331	1.3417

\*PLAN COMPACT only.

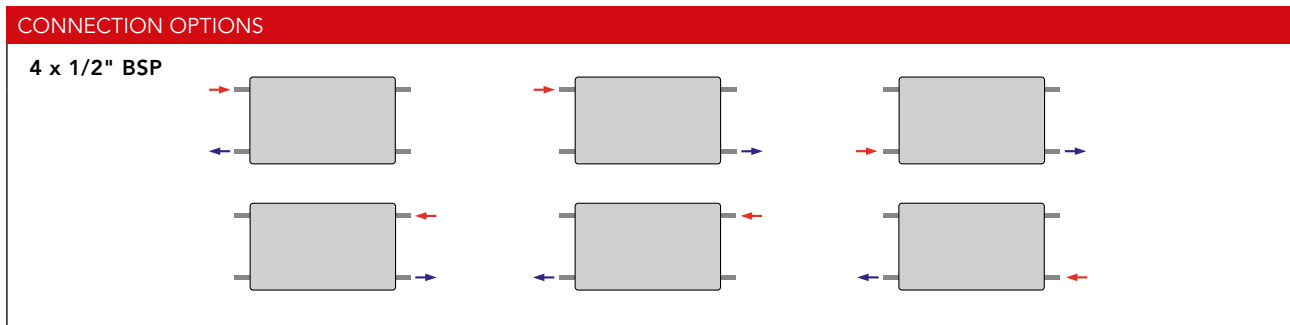

**MOUNTING POSITIONS & DIMENSIONS**

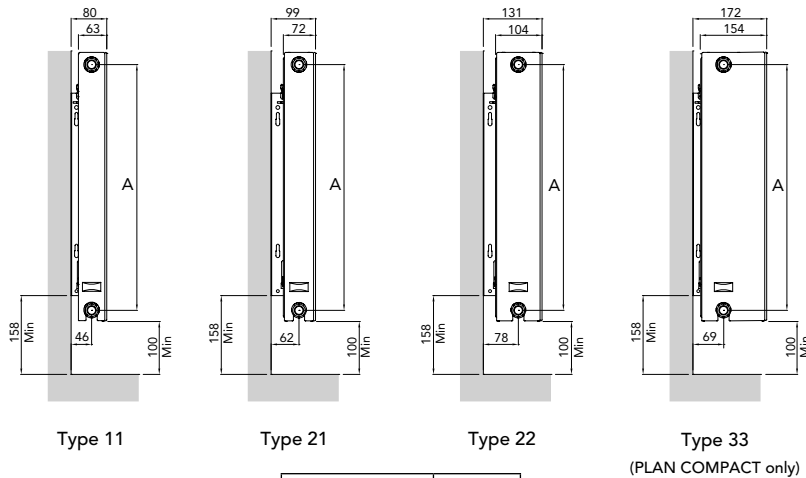

**Top View**

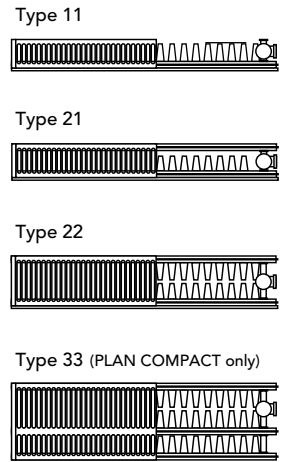

Nominal Height (mm)	A (mm)
300	250
400	350
500	450
600	550

**BRACKET POSITIONS & DIMENSIONS**

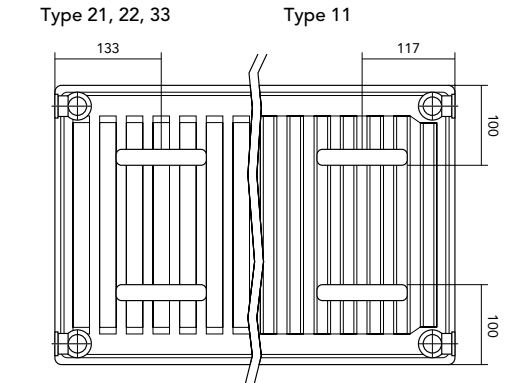

Bracket for use on - Type 11 and 33

Bracket for use on - Type 21 and 22

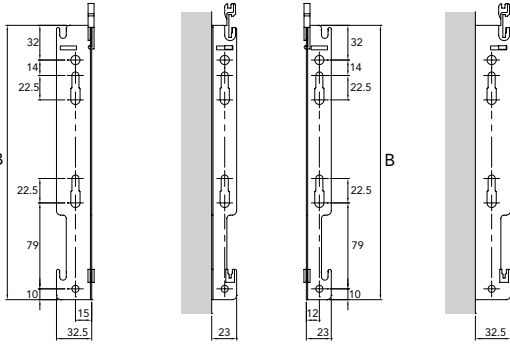

Nominal Height (mm)	B (mm)
300	153
400	253
500	353
600	453

**FLOOR BRACKETS**

**Floor Brackets**

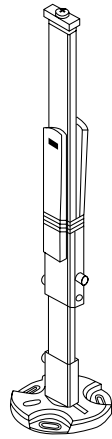

Floor brackets for Types 21, 22 and 33:

- Radiator to wall distance: Any
- Maximum load of a single bracket: Vertically - 180kg, Pulling - 35kg

**Order Code:** RH033 (single piece)

Height 300 - 600mm		Height 700mm	
Radiator length (mm)	Quantity of floor brackets	Radiator length (mm)	Quantity of floor brackets
400 - 1800	2	300 - 1200	2
2000 - 2400	3	1400 - 1600	3

NB: All measurements are nominal.



