

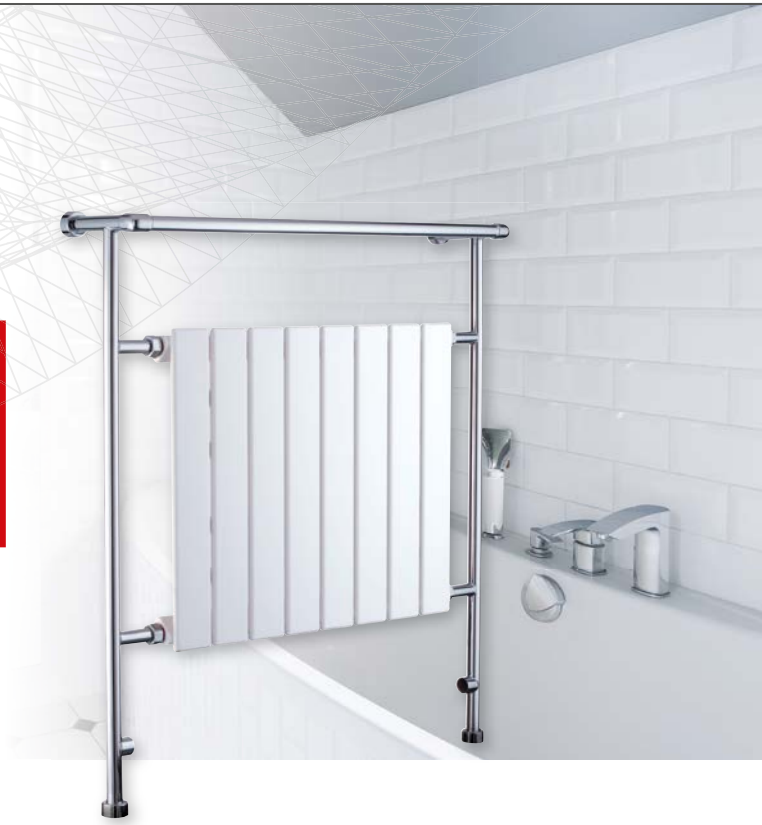

SOKOTO

SOKOTO is a stylish and distinctive combination radiator. It is highly practical, with a flat tube DÉCOR radiator at its centre, giving it not only high heat outputs, but an attractive appearance. The outer rail is manufactured from high quality brass with an attractive polished chrome plated finish which gives it a truly modern feel.



GENERAL SPECIFICATION

- CERTIFICATION**
Manufactured and tested to BS EN 442. Carries the BS Kitemark. Produced under an environmental management system - ISO 14001:2004.
- SYSTEM**
2 pipe pumped indirect domestic and commercial heating applications.
- CONNECTIONS**
2 x 1/2" BSP as standard.
- AIR VENTS**
Integrated.
- OPERATING PRESSURES**
Tested to a pressure of 6.9 bar. Working pressure of up to 5.3 bar.
- DELIVERY**
2 - 5 working days.
- VALVES**
Please see page 118.
- 10 GUARANTEE**
10 year guarantee from date of purchase against manufacturing defects.
- COLOUR**
Frame finished in chrome. Radiator in white (RAL 9016).
- MATERIAL**
Frame manufactured from brass. Radiator manufactured from steel.
- A ACCESSORIES**
Please see page 118.

For more general information, please see page 242.

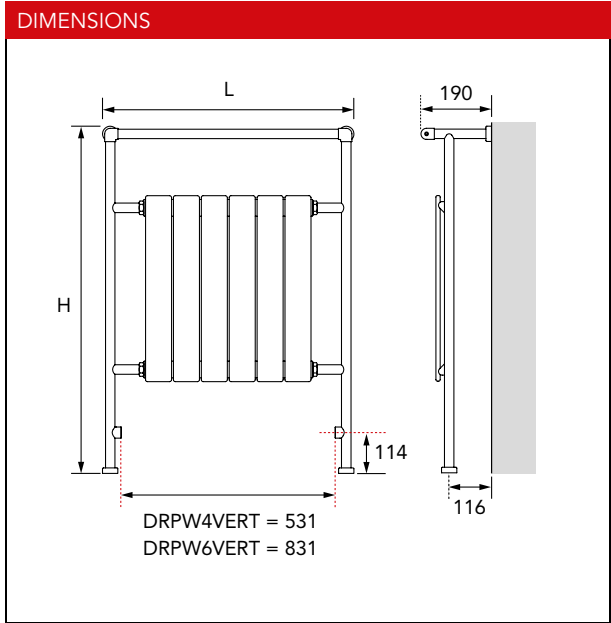

WEIGHTS & n-COEFFICIENTS		
Model	Weight (kg)	n-Coefficient
DRPW4VERT	13.70	1.224
DRPW6VERT	18.80	1.224

Order Code	Nominal Height (H) (mm)	Nominal Length (L) (mm)	Heat Outputs @ ΔT 50°C		Heat Outputs @ ΔT 30°C	
			Watts	Btu/h	Watts	Btu/h
DRPW4VERT	934	636	387	1320	207	706
DRPW6VERT	934	936	559	1907	299	1020